

Serial No. _____



CENTREX 3000

OWNER'S MANUAL



CENTREX 3000



CENTREX 3000 NE



Certified to NSF/ANSI Standard 41

Standard 41

Certified for liquid containment,
odors, and solid end products in
both residential and cottage use

RATED CAPACITY

Residential & Continuous Use

CENTREX 3000: 6 Adults

CENTREX 3000 NE: 5 Adults

Weekend & Vacation Use

CENTREX 3000: 9 Adults

CENTREX 3000 NE: 8 Adults

Models for which the manual applies:

CCEB-02510 Centrex 3000 115V

CCNB-02540 Centrex 3000 NE

CCEB-02515 Centrex 3000 230V



Unit must be installed so electrical components in the base are protected from rain, flooding and melting snow.

Place the warning and cleaning sticker on the inside lid of the ultra low flush toilet.

Metal tools will damage the toilet.

OWNER'S MANUAL

CONTENTS

How Composting Works	2	Ongoing Maintenance	11
The CENTREX 3000 Toilet	3	Spring Time Start Up	12
The Patented Bio-Drum	3	Winter Use	12
Compost Finishing Drawer	3	Compost Troubleshooting	13
Evaporation Chamber	3	Compost Too Wet	13
Inspection	4	Waste is not Breaking Down	13
Check for Damage	4	Lumps In Drum	13
What's in the Box	4	Drum Too Full	13
Familiarize yourself with the CENTREX 3000	4	Flies Present	13
Placement of the unit	4	Mechanical	
Installation	5-7	Troubleshooting	14-16
CENTREX 3000 Rough in Dimensions	5	Urine Odor In Washroom	14
COMPACT Rough in Dimensions	5	Occasional Urine Odor Outside	14
CENTREX 3000 Electric Installation	6	Strong Sewage Odor	14
Space requirements	6	Fan Noisy	14
Vent Piping Location	6	Fan Not Working	15
Electrical Considerations	6	Liquid Buildup/ Lack of Evaporation	15
CENTREX 3000 NE Installation	7	Liquid Overflow	15-16
Space requirements	7	Heating System Not Working	16
Vent Piping Location	7	Liquid In Finishing Drawer	16
Installation Common To Electric And NE Units	8	Drum Will Not Turn	16
Leading the vent through the Roof	8	Drum Door Not Opening/ Closing	16
Leading the vent through the wall	8	Basic Instructions	17
The Diffuser	8	Composting Toilet Accessories	18
Drain Installation	8	CENTREX 3000 Specifications	19
Handling Effluent	8		
Positioning The Collection Chamber	9		
Installing The Wastepipe	9		
Installing The Ultra-Low Flush Toilet	9		
Start Up And Use	10		

HOW COMPOSTING WORKS

Composting is the natural process of decomposition that can be helped along by providing the ideal conditions to help your composting toilet work at peak performance. The ideal conditions for decomposition to occur depend on several factors: oxygen, temperature, moisture content, and the carbon/nitrogen ratio.

Oxygen

Oxygen is very important in composting. Your compost should be aerated in order to encourage aerobic bacteria growth. Aerobic bacteria are bacteria that grow and live in the presence of oxygen and are very efficient in breaking down waste. To aerate the compost and encourage the growth of these bacteria, the compost drum should be turned three times per week (10 complete turns of the drum).

Temperature

Temperature is another important consideration when composting. Optimal composting temperatures range between 70-100 ° F (21-38 ° C). Decomposition will slow significantly or stop completely if the compost becomes too cold (below 55 ° F or 13 ° C). If you are in an area that experiences temperatures below 55 °F (13 ° C) additional heat is required if the composting toilet will be used continually or frequently. If used for intermittent cottage application (3 - 4 weekends throughout the cold season) no additional heat is required. The unit will function as a holding tank until the temperature warms up.

Moisture

Moisture is necessary to achieve good compost. Your compost should always be damp, like your garden after you have watered it. This moisture allows the bacteria to travel around in the compost so that they can speed decomposition by digesting the waste. If the compost is too dry, the bacteria cannot survive and decomposition will slow or cease. When adding water to the compost, you are aiming for damp compost, not saturated. Too much liquid in the compost limits the amount of oxygen that aerobic bacteria require to survive. If normal urination is not enough to maintain the correct moisture level in the compost, we encourage you to add additional water to the drum.

Carbon/Nitrogen Ratio

Almost all organic material will compost. The proper bulking material and human waste should be added to the composting toilet. In order to maintain a good balance between carbon-rich materials (SUN-MAR Compost Sure Blue) and nitrogen-rich human waste only.

THE SUN-MAR CENTREX 3000 TOILET

The key to the success of the CENTREX 3000 lies in its three chamber design. Each of the three chambers; patented Bio-drum, compost finishing drawer, and evaporation chamber, have their own independent environments for optimum efficiency. The CENTREX 3000 electric version has a thermostatically controlled heater and fan assembly to help evaporate liquid and should be used where there is a constant electrical supply. The CENTREX 3000 NE (non-electric) version is for use where there is no continuous electric supply. The CENTREX 3000 NE has no heater but does include a 12 volt fan. Odorless operation is achieved by a 4" vent assisted by the fan which acts like a chimney creating a partial vacuum within the unit.

The Patented Bio-Drum

Unique to Sun-Mar, the patented bio-drum provides the necessary mass to maintain good compost and allows easy aeration of the compost by simply turning the drum. Excess liquid will exit through a screen in the bottom of the drum into the evaporation chamber. Mixing the Bio-drum is accomplished by rotating the handle in a clock-wise direction. Compost moves automatically through the drum with SUN-MAR's unique **Autoflow**® technology.

The Compost Finishing Drawer

The compost finishing drawer sits in the opening in the front right of the unit. Since the CENTREX 3000 automatically discharges finished compost into the collection chamber at the end of the unit, this drawer is used only if you need to remove all compost from the drum. Removal of the compost finishing drawer and access panel allows access to the evaporation chamber for cleaning and maintenance purposes.

The Evaporation Chamber

The evaporation chamber is the floor of the unit under the compost finishing drawer. This is the area where any excess liquid will gather for evaporation. A safety drain exits from the left side of the composting toilet which will drain over-flow liquid that is not evaporated to an approved facility.

The Collection Chamber

CENTREX 3000 units incorporate SUN-MAR's unique **Autoflow**® technology. As the drum rotates, compost moves automatically through the drum and into a separate collection chamber located near the end of the unit.

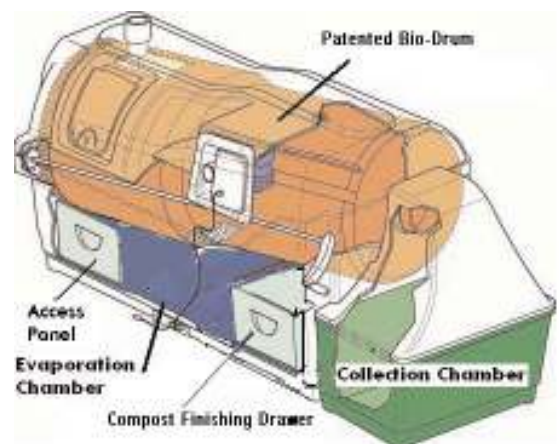

Inspection

We recommend an inspection of the CENTREX 3000 prior to installation and to make sure you have received all of the parts required as listed below.

<p>Inspecting the unit for Damage</p>	<ol style="list-style-type: none"> 1) If there is any visible damage to the carton- The contents of the carton should be inspected before signing the bill of lading. Damaged units should be refused. Call Sun-Mar immediately. 2) If the shipper has left- Report the damage immediately to the shipping company and call Sun-Mar. 3) Soon after delivery, remove the CENTREX 3000 Toilet carefully from the carton- If there is hidden damage, or for any service questions, contact Sun-Mar to determine the best course of action. 												
<p>What's in the Box</p>	<table border="0"> <tr> <td>1- Owners Manual</td> <td>1- 6" (150mm) Diffusor (NE)</td> </tr> <tr> <td>1- Warranty Card</td> <td>1- Collection Chamber</td> </tr> <tr> <td>1- Hardware Kit</td> <td>6- 2" x 30" (76.2cm)PVC Pipe (Electric)</td> </tr> <tr> <td>1- 8' 4" (254cm)1" ID Drain Pipe</td> <td>2- Compost Sure Blue</td> </tr> <tr> <td>1- Rake</td> <td>1- 4" Diffusor (100mm)(Electric)</td> </tr> <tr> <td>1- 12 Volt 2.4 Watt Fan (NE)</td> <td>5- 4" x30" (10.16 x 76.2cm)ABS Pipe(NE)</td> </tr> </table>	1- Owners Manual	1- 6" (150mm) Diffusor (NE)	1- Warranty Card	1- Collection Chamber	1- Hardware Kit	6- 2" x 30" (76.2cm)PVC Pipe (Electric)	1- 8' 4" (254cm)1" ID Drain Pipe	2- Compost Sure Blue	1- Rake	1- 4" Diffusor (100mm)(Electric)	1- 12 Volt 2.4 Watt Fan (NE)	5- 4" x30" (10.16 x 76.2cm)ABS Pipe(NE)
1- Owners Manual	1- 6" (150mm) Diffusor (NE)												
1- Warranty Card	1- Collection Chamber												
1- Hardware Kit	6- 2" x 30" (76.2cm)PVC Pipe (Electric)												
1- 8' 4" (254cm)1" ID Drain Pipe	2- Compost Sure Blue												
1- Rake	1- 4" Diffusor (100mm)(Electric)												
1- 12 Volt 2.4 Watt Fan (NE)	5- 4" x30" (10.16 x 76.2cm)ABS Pipe(NE)												
<p>Familiarize Yourself with the CENTREX 3000 Toilet</p>	<ol style="list-style-type: none"> 1) Turn the drum handle clockwise to rotate the patented Bio-Drum for mixing and aeration. (The drum rotates counter-clockwise and the drum door closes). This is how you will rotate the drum during regular operation. 2) Lift and remove the access door and rotate the drum until the drum opening is visible through the access door opening for adding "Compost Sure Blue". This is how you will add "Compost Sure Blue" bulking mixture to the drum during regular operation. 3) Plug the unit's electrical cord (Electric) into a standard three-prong Electrical outlet, and feel the air movement from the vent outlet at the front of the unit to ensure the vent system is working properly. 4) Pull out the compost finishing drawer at the bottom right of the unit. After the unit has been plugged in for ten minutes, place a hand on the floor of the evaporating chamber (the area under the finishing drawer) to check it is warm to the touch, and that the heater is working properly. 												
<p>Placement of Unit</p>	<p>The unit should be installed so that the base is protected from weather. The rubber "u" channel at the bottom of the unit is well-sealed, but if the unit is sitting in water, has snow melting against it, or rain pouring on it, this may eventually wear through and short out the heating element. Install your unit with a protective cover of some kind to protect it from precipitation from reaching it. The composting unit should be placed on a level surface or sloping slightly toward the safety drains assembly to ensure drainage of effluent. Do not install the unit in a pit where water can accumulate around the composter.</p>												

Installation

CENTREX 3000 ROUGH IN DIMENSIONS

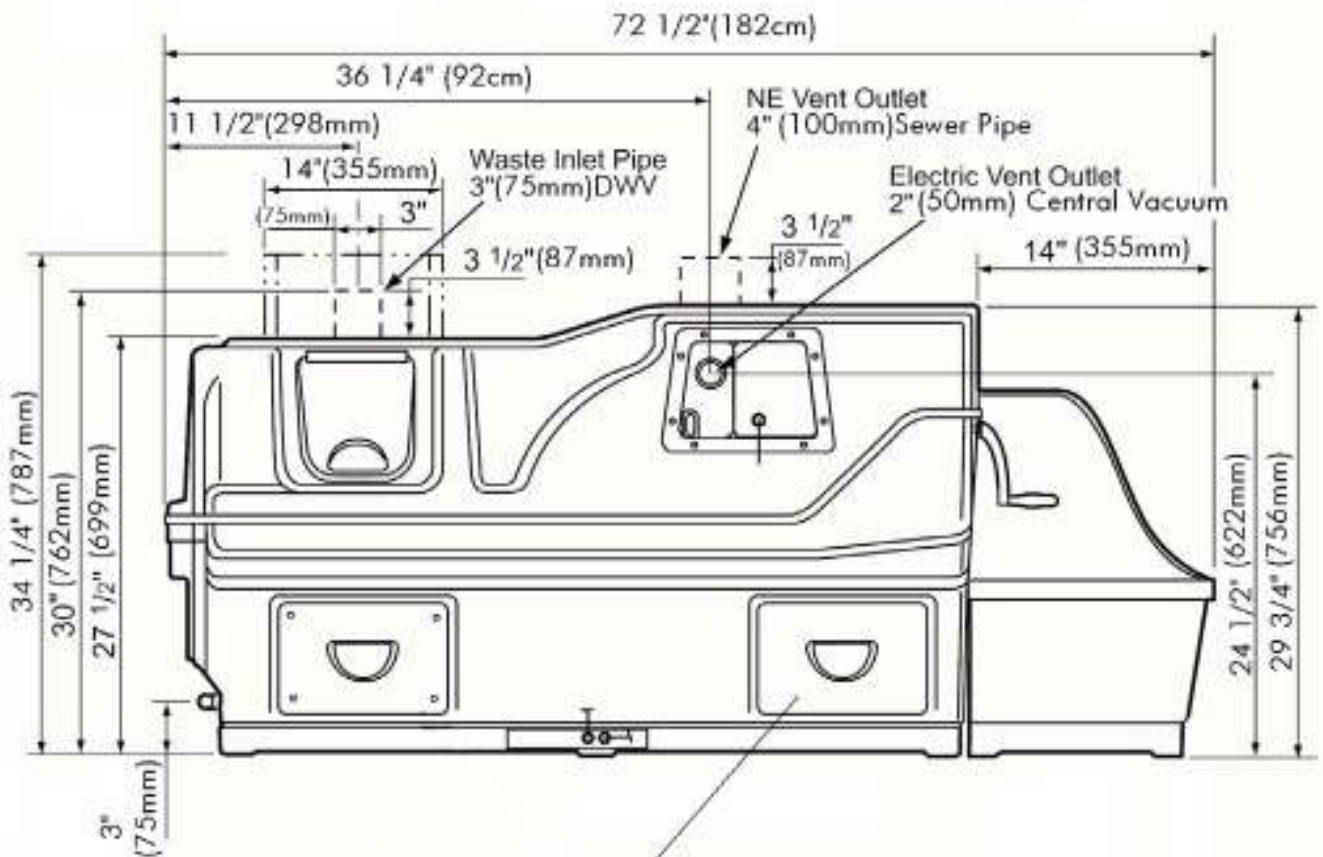
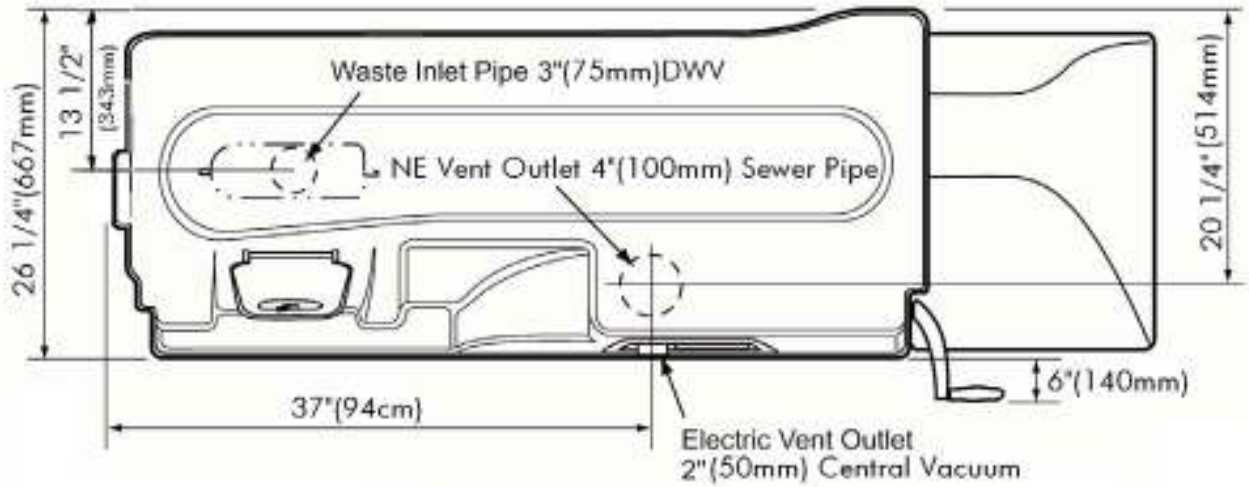

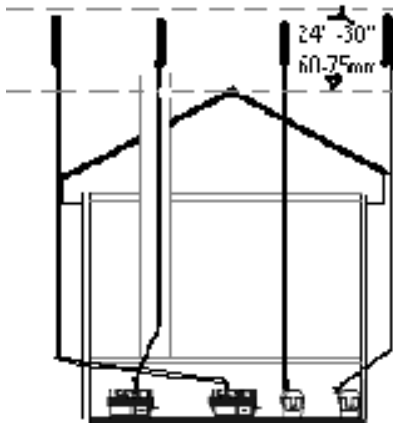

NOTE: When removing the drawer an additional 18" (46cm) depth is required

CENTREX 3000 Electric Installation



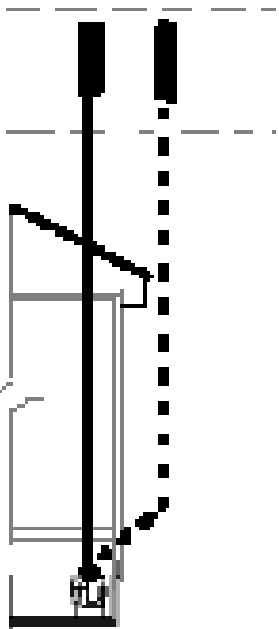



<p>Space Required and other Installation Considerations</p>	<ol style="list-style-type: none"> 1) To facilitate maintenance and compost removal, ensure that there is at least 17" in front of the CENTREX 3000, for removal of the drawer and access panel. 2) The safety drain is required in ALL installations. Install the unit in a location where the safety drain can be connected. This drain exits from the left side of the unit and must slope downward at all points. 3) Install in a location where the vent pipe can be attached as per the instructions listed below. 4) Install in a location that is not air tight. The toilet must be able to vent to ensure odor free operation. 5) Ensure that the CENTREX 3000 is accessible for ongoing maintenance. 6) Ensure that the installation area is a minimum height of 28". WE DO NOT RECOMMEND DIGGING BELOW GROUND TO FACILITATE THE INSTALLATION OF THE CENTREX 3000. 7) Ensure the CENTREX 3000 is protected from precipitation. 8) Ensure that the unit is installed on a level surface or sloping slightly towards the safety drain.
<p>Vent Pipe Location</p>	<ol style="list-style-type: none"> 1) If running a vent through a wall, it should be done at a 45° angle to prevent condensation from accumulating in the vent pipe, causing a constriction. NO HORIZONTAL SECTIONS OF VENT. Venting should be installed vertically. 2) All vent pipe that is exposed to the outside or in a non-heated space should be insulated if using the unit during cold weather. 3) INSTALL VENT SO THAT IT TERMINATES 24" - 30" ABOVE HIGHEST PEAK OF THE ROOF. 4) If you will be installing venting on a steeply pitched roof where snow shear may occur; Install a heavier pipe through the roof and feed the enclosed vent through the heavier pipe. Seal between the pipes with expandable foam or other such water-tight substance. The heavier pipe should be able to withstand the weight of sliding snow. 5) If there is more than 36" of vent needed above the roof line to reach 24-30" above the highest peak of the roof (diffusor included in measurement), use guy wires to secure the vent above the roof. 6) Limit bends in the vent stack to no more than 4 that have a combined total of 180 °. 7) The vent must be installed separately from ALL other household vents. Venting cannot be merged with other venting. Doing so will prevent the unit from operating in an odorless fashion. 8) All connectors in the vent pipe should be sealed. Use silicone caulking to seal the connection between the vent and the fan. PVC cement may be used on all other vent connections. 9) The diffusor should be glued vertically on to the top of the vent pipe. This assembly helps draw air up the vent pipe. <p style="text-align: center;"><i>Possible venting configurations for the 2" electric vent pipe.</i></p> 
<p>Electrical Considerations</p>	<p>The fan will run continuously 24 hours per day. A ground fault interrupter (GFI) circuit is recommended for any unit installed in an environment where it will be exposed to moisture. This may be installed directly on the wall socket or at the circuit breaker. If you are in an area where you experience power fluctuations, you may wish to install a surge protector.</p> <p>Some 230V models may have an over current fuse protection on the heating element circuit which is located on the electric box.</p>

CENTREX 3000 NE (Non-Electric) Installation

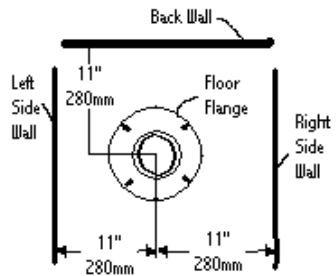
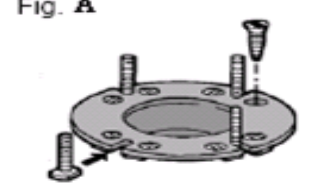
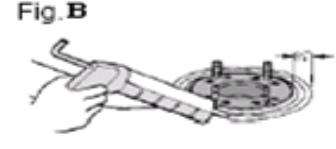
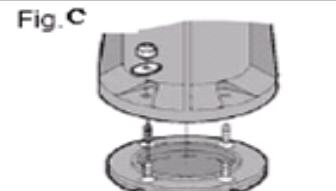
<p>Space Required and other Installation Considerations</p>	<ol style="list-style-type: none"> 1) To facilitate maintenance and compost removal, ensure that there is at least 17" in front of the CENTREX 3000, for removal of the drawer and access panel. 2) The safety drain is necessary for ALL installations. Install the unit in a location where the safety drain can be connected. This drain exits from the left side of the unit and must slope downward at all points. 3) Install in a location where the vent pipe can be attached as per the instructions listed below. 4) Install in a location that is not air tight. The toilet must be able to vent to ensure odor free operation. 5) Ensure that the CENTREX 3000 NE is accessible for ongoing maintenance. 6) Ensure that the installation area is a minimum of 28" in height. WE DO NOT RECOMMEND DIGGING BELOW GROUND TO FACILITATE THE INSTALLATION OF THE CENTREX 3000. 7) Bends in the vent, installation near hills or over hanging trees may cause down draft. A 12 volt fan may be necessary. 8) Competing appliances (ie. wood stove) may require an air intake installed from the outdoors if the unit is installed in an enclosed basement. A 12 volt fan may be required. 9) Ensure that the unit is installed on a level surface or sloping slightly towards the safety drain. 	
<p>Vent Pipe Location</p>	<ol style="list-style-type: none"> 1) All vent should be vertically installed. 2) Limit bends in the vent stack to no more than 2 - 45 ° bends. NO HORIZONTAL SECTIONS OF VENT. 3) INSTALL VENT SO THAT IT TERMINATES 24" - 30" ABOVE HIGHEST PEAK OF THE ROOF. If the vent is being installed on a steeply pitched roof where snow shear may occur; Install a heavier pipe through the roof and feed the enclosed vent through the heavier pipe. Seal between the pipes with expanding foam or other such water-tight material. The heavier pipe should be able to withstand the weight of sliding snow. 4) If there is more than 36" of vent needed above the roof line to reach 24-30" above the highest peak of the roof (diffuser included in measurement), use guy wires to secure the vent above the roof. 5) The vent must be installed separately from ALL other household vents. Venting cannot be merged with other venting. Doing so will prevent the unit from operating odorlessly. 6) All connectors in the vent pipe should be sealed. Use silicone caulking to seal the connections. 7) The diffuser should be glued vertically on to the top of the vent pipe. This assembly helps draw air up the vent pipe. 	
<p>Vent Inlet Coupling</p>	<p>Place the vent inlet coupling into the hole on the top of the unit for the 4" vent and so that the 1" of smaller diameter pipe is protruding into the hole. This is the first piece of the venting. Once you have finished assembling the vent, run a bead of silicone around where the inlet coupling meets the top of the composting unit to prevent odor from escaping.</p>	
<p>12 Volt Fan</p>	<p>Install the 12 volt fan on the inlet coupling with the large side with the wires protruding facing upwards (as shown in the picture at right). When the 12 volt fan is turned off, it forms an obstruction in the vent, and should therefore run continuously while the cottage or home is occupied. An optional switch (as small as 1 amp) may be installed, and the fan turned off when the toilet will not be used for several weeks. The red wire should be connected to the positive (+) terminal on your battery or DC system, and the blue wire to the negative terminal (-). The 12 volt fan may be powered with a battery that is connected to a generator, solar panel, or other alternative energy system.</p>	

Installation Common To Electric and NE Units

<p>Leading the vent through the roof</p>	<p>The vent stack (shown in diagram) should end approximately 30" above the peak of the roof so that it is less subject to downdraft. Where the pipe is taken through the roof, a roof flashing may be required to seal the installation. If you are in an area where snow shear is a danger, you may wish to install a heavier pipe around the vent pipe where it exits from the roof. If you do choose to do this, ensure that you seal the area between the pipes with a waterproof substance to prevent leaks.</p>	
<p>Leading the vent through the wall</p>	<p>When it is necessary to lead the vent through a wall, connect one 45° elbow on the vent outlet on the unit. Using a hole saw or other appropriate tool, cut a hole through the wall board behind the unit so that the vent pipe can be inserted into the 45° elbow. Cut a similar hole on the other side of the wall that is slightly higher than the inner hole so that the vent pipe will be angled upward at 45°. If installing through an exterior wall, waterproof sealant will be required around the vent pipe where it emerges from the building.</p>	
<p>The Diffusor</p>	<p>The diffusor provided with the unit is a simple device to be installed at the top of the vent stack with the larger pipe protruding above the smaller. To install, simply glue the diffusor vertically on the topmost section of vent pipe. The diffusor design encourages updraft, and discourages wind and weather from going down the vent stack. We do not recommend installing anything else on the top of the vent as it could impede the venting. Unlike wind turbines, diffusors are less likely to freeze in winter, and are more effective in calm weather.</p>	
<p>Drain Installation</p>	<p>The safety drain MUST be connected as it will be required in all Centrex 3000 NE installations or Centrex 3000 electric with ultra-low flush toilets.</p> <ul style="list-style-type: none"> - Remove the orange cap from one side of the overflow drain assembly. - Place a 1" hose clamp over the end of the drain hose that will be connected to the overflow drain assembly. - Push the drain hose over the ribbed end of the over-flow drain and clamp with the 1" SS hose clamp. - Connect the 1" hose to an approved drainage facility. - The safety drain is gravity fed. The drain hose must be below the level of the safety drain in order to function. 	
<p>Handling Effluent</p>	<p>The following are possible options to take care of the liquid :</p> <ul style="list-style-type: none"> - Feed into a lined pit filled with gravel and sand. Such a recycling bed also ensures a closed loop system. - Feed into a small cesspit or "French drain". - Plumb into an existing septic or holding tank line. <p>Installation should be in accordance with applicable local regulations.</p>	

<p>Positioning The Collection Chamber</p>	<p>Line the bottom of the collection chamber with the plastic bag (provided). Place the collection chamber base on the right side of the CENTREX 3000 so that the base rests under the opening in the patented bio-drum. Place the top of the collection chamber on the base. SUN-MAR Autoflow® technology allows compost to automatically deposit into the collection chamber.</p>	
<p>Installing the waste pipe</p>	<p>When installing the waste pipe from the toilet to the unit, the following should be considered:-</p> <ol style="list-style-type: none"> 1) The pipe should be either 45 ° or vertical (if composting unit is directly below toilet), or at a 2-3 ° angle (1/8" -1/4" or 3-13mm drop per foot maximum) so that the waste travels with the liquid. 2) Pipe should not slope upwards at any point. 3) Connections should be snug so that waste does not cause blockage. 4) It is recommended that the waste pipe be no longer than 15 feet (460cm) without installing a clear out port(a Y fitting with screw on end cap) near the toilet to provide easy access should it be required. 5) Use a soft sealant, such as silicone for the connection of the waste pipe to the unit so that the unit can be moved for servicing or other reasons should this ever be required. 6) Insulate pipe if unit is to be used during the winter. 7) For longer installations of waste pipe, ensure the waste pipe is supported to prevent sagging. 	
<p>Installing the Ultra Low Flush Toilet</p>	<ol style="list-style-type: none"> 1) Make sure the center of the floor flange is at least 11 inches (280mm) from the back wall. 2) When installing a new floor flange, ensure that the toilet mounting bolts align properly with ultra low flush toilet mounting pattern. 3) Secure flange to floor using flat head screws through counter-sunk holes in flange. Insert bolts into slotted holes in flange(Fig. A) 4) Position floor seal by pressing the floor bolts up through the holes in the seal. 5) Set toilet in place with bolts protruding up through mounting holes in base (Fig C). 6) Install washers and hex nuts provided with toilet. Tighten nuts down equally with standard 7/16" (12mm) open end wrench. 7) Connect water supply line to water valve (1/2" or 13mm MPT) inlet using appropriate fittings (Fig D) 8) Turn on water supply and flush toilet to test for leaks. 9) Attach pedestal and pedal covers to toilet base. See instructions below. 	 <p>Fig. A</p>  <p>Fig. B</p>  <p>Fig. C</p>  <p>Fig. D</p>
<p>PEDESTAL AND PEDAL COVER INSTALLATION</p>		
<p>ALL TRAVELER TOILETS AND TRAVELER LITE MODEL 111:</p>		
 <p>1. Wrap pedestal cover around base so that it closes as shown.</p>	 <p>2. Tall model – screw cover together. Short model – snap together.</p>	 <p>3. Slide pedal cover onto foot pedal rod.</p>
 <p>4. Secure side plate onto pedal cover with screws.</p>		

Initial Start Up and Use

These steps are only used when starting up your CENTREX 3000 toilet for the first time or when you have emptied the drum and need to re-start the compost.

After installation is completed do the following:

Step 1 : Spray Compost Quick: Remove the finishing drawer and spray the whole inner floor of the unit under the finishing drawer. Spray Compost Quick into the patented bio-drum and the inside of the finishing drawer.



Step 2: Pour 1 bag of Compost Sure Blue into a bucket and add 2 quarts of warm water. Add 1/2 of the Microbe Mix packet to the bucket. Allow the Compost Sure Blue to absorb the water (about an hour).



Step 3: Scoop the Compost Sure Blue mixture into the patented Bio-Drum through the access door on the CENTREX 3000. Rotate the drum to mix. The opening in the drum must remain open under the waste pipe. The CENTREX 3000 toilet is now ready for use.



Step 4: For electric units only. The fan will run continuously 24 hours per day.
120 Volt Use: Plug it in to a three prong electrical outlet.
240 Volt Use: The unit must use a mains plug with an earth connection. Replacement of electrical components (including the power cord and mains plug) must be performed by a qualified person to avoid hazard.

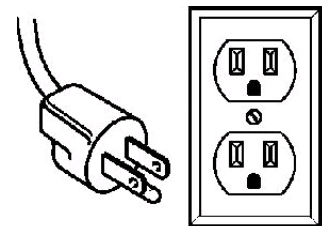

When you first start up the CENTREX 3000, it will take approximately 6 weeks at optimum temperatures (70-90 ° F) before you will have sufficient quantities of microbes in the drum to actually achieve good compost. During this time, the contents of the patented bio-drum start out as Compost Sure Blue and waste. Over the first 6 weeks, you will notice that the compost will hold moisture and will become more uniformly dark in color. During the first six weeks, you may notice that some Compost Sure Blue has fallen through the drum screen onto the evaporation chamber to the left of the finishing drawer. This should be raked out and removed with the rake tool provided with the unit.

NOTE: Regular toilet paper may be used. Toilet paper is a good source of carbon for your compost so it may be added to the Bio-Drum™

Ongoing Toilet Maintenance

Once your CENTREX 3000 toilet is installed and you have gone through the initial start-up procedure, follow the steps outlined below to keep your composting toilet working optimally.

<p>Add one cup of Compost Sure Blue per person per day of use</p>	<p>Even if you only use the toilet for urination then at least one cup of Compost Sure Blue should be added per person per day of use. Add the Compost Sure Blue through the access door CENTREX 3000 toilet. The Compost Sure Blue should be added to the composting unit, just prior to turning the drum.</p>
<p>Spray Compost Quick on the surface of the compost</p>	<p>Every second day before turning the handle, spray 3-4 sprays of Compost Quick on the surface of the compost. Compost Quick is an enzyme that will speed up the composting process.</p>
<p>Turn the handle clockwise every second day to mix the compost</p>	<p>Turn the handle in a clockwise direction to mix and aerate the compost. When mixing, ensure that the drum rotates 10 complete revolutions (70 turns of the handle).</p>
<p>Make sure that the opening in the drum is centered under the waste pipe.</p>	<p>The hole in the drum must be open under the waste pipe, ready to receive waste.</p>
<p>Every two weeks</p>	<p>Add one scoop of Microbe Mix to the patented bio-drum to 'recharge' the pile. This will help to ensure your microbe colony stays constant and healthy.</p>
<p>Every three months</p>	<p>Rake the evaporation chamber: Remove the finishing drawer. Rake any solid debris from the floor of the unit under the drawer (evaporation chamber), paying extra attention to the left corners of the unit as this is where debris may accumulate. Remove the solid debris.</p>
<p>Twice per year</p>	<p>Clean the drum screen. Spray the drum screen with Compost Quick and let sit for 15 minutes (this will help to loosen the debris if the screen is not too encrusted). Scrub the screen vigorously with the wire brush. If brushing the screen does not clear it and liquid is still not draining through the screen, you may have to resort to having to use a screwdriver or nail to puncture each hole in the drum screen.</p>
<p>Periodic maintenance</p>	<p>Empty the collection chamber.</p>

CAUTION

- 1) **Do NOT** add or clean the toilet bowl liner with chemicals. Chemicals will kill the bacteria. **INSTEAD**, clean the bowl liner with Compost Quick.
- 2) **Do NOT** add plastic, glass, metal, cleaning fluids, cigarettes. Add only waste and bulking material.
- 3) Kitchen or garden waste, are **NOT** recommended.
- 4) **Do NOT** add baby wipes, diapers or feminine paper as they will not compost.

Seasonal Use and Springtime Start Up

Rake

Remove the finishing drawer and access panel completely and use the rake tool to rake any loose material from the floor of the unit. Careful attention should be paid, to the left two corners of the unit (near the safety drain) to ensure that your drains do not get clogged.

Add Water & Microbe Mix

Add some warm water to the remaining compost, enough to ensure that it is quite moist. Also, add some Sun-Mar Microbe Mix (two of scoops) to give the compost pile a “kick-start” and rotate the drum several times to mix. If your composting toilet is electric, plug it in and use for another season.

Winter Use

No Winter Use

Just add water, lots of water. Soak the compost in the drum to prevent it from drying out before Spring. Make sure to unplug the unit if electric. If you have a non-electric unit, it may be a good idea to place something over the diffuser to prevent animals (who are looking for a home at this time of year) from getting in.

Occasional Winter Use

If the unit will be used for 3-4 weekends throughout the winter season then it is considered occasional use. All of the same considerations should be taken with these units to winterize them. When the temperature dips below 55 ° F (13 ° C), composting activity will decrease dramatically. These units do not need to be kept warm and will act only as a holding tank during the winter months until they warm up enough in the spring to begin composting again. During the winter, the compost will freeze into a solid mass so the drum should not be turned as it may damage the composting toilet. With this in mind, it is a good idea to remove enough compost before it gets too cold to make room in the drum for winter use.

Heavy or Residential Winter Use

These units should be kept in a heated area and all winterization tips should be followed, including the following:

- 1) Vent Pipe - electric models; all 2" vent pipe should be insulated if they are exposed to the outside or in an unheated area. If you are in an area that experiences extreme winter conditions, we recommend that heat tape should be applied to the exposed vent pipe to prevent ice blockages.
- 2) Safety Drain - all models; we recommend that the safety drain should be installed and insulated above the frost line. There will be less evaporation in the winter so this will help with any excess liquid. If possible, heat tape can be applied to the safety drain to prevent ice blockage.
- 3) Keep it warm; If the composting toilet is used frequently in the winter then the composting part of the unit should be kept in a warm place. Below 55 ° F (13 ° C), composting actions slows dramatically so if it is in a place that falls below this temperature, a source of heat should be provided for the unit so that it can keep up with constant use.

Warning: The water valve must be drained (or removed) if the ultra low flush toilet is installed in an area where freezing temperatures are anticipated to prevent freezing and cracking of valve.

Compost Troubleshooting

Symptom	Cause	Remedial Action	Prevention
Compost Too Wet	Compost porosity is poor.	Change bulking material to Compost Sure Blue.	Use Sun-Mar Compost Sure Blue
	Drum screen clogged	Spray the drum screen with Compost Quick. Scrub the drum screen with wire brush.	
	Insufficient moisture in compost	A moisture content of 40-60% is ideal for aerobic microbes to thrive.	Add water to patented bio-drum
Waste not Breaking Down at all (the drum will fill up quickly)	Insufficient Microbes	Add Sun-Mar Microbe Mix.	Be sure to add microbe packet at start up.
	Room Temperature Under 55 ° F/13°C	Install heat source to increase temperature. Temperature should be kept above 55 ° F/13°C constantly to ensure the composting action does not stop completely.	Install unit in warm area. The warmer the area, the better your compost will be!
Large Lumps in Compost	Compost Too Dry	Add 1/2 to 1 gallon of warm water to compost in order to bring it up to appropriate moisture level. Remove lumps or break them apart.	Use proper bulking material and add warm water if necessary.
Drum Too Full	Compost Bio-Drum not rotated enough	Remove compost until drum is only half full or less. Rotate compost thoroughly to aerate, and add compost accelerant, (Compost Quick and Microbe Mix) if available.	Rotate the drum, 10 full revolutions, every other day. Do NOT let drum get above 1/2 full. This will lead to lack of aeration, and anaerobic compost.
Flies Present	Kitchen/Garden Waste added	We do not recommend adding kitchen or garden scraps.	Do Not add kitchen or garden waste.
	-compost too dry -compost anaerobic -foreign material added	1) To eliminate flies, you can use any pesticide that is used on your garden. Pesticides used for garden use are not anti-bacterial so are safe to use on your compost. 2) The alternative to using pesticides is to completely clean the toilet out, wash the inside with soap and water IMPORTANT: Application of a pesticide in a SUN-MAR toilet is not a health concern because all SUN-MAR units are vented. If using pesticides, avoid spilling on the outer shell of the composter	1) Keep compost moist. In order to determine a good level of moisture, shine a flashlight into the drum. The compost should have a slight gloss or shine. If it does not, add warm water to it until it reaches this consistency. Fungus gnats tend to be attracted to a dry compost, due to the fungus which begins to form on the surface when it dries out. A good, moist compost will not be attractive to flies. 2) Do not add topsoil from the ground, composted matter, or kitchen scraps to the toilet. Flies may be present in, or attracted to these items. 3) Use "Compost Sure Blue".

MECHANICAL TROUBLE SHOOTING

Symptom	Cause	Remedial Action	Prevention
Urine Odor in Washroom	Horizontal runs or downward slopes on vent pipe	Re-install the vent so there are no horizontal or low points where condensation can collect.	Install wall brackets on vent pipe to prevent settling. DO NOT install horizontal runs as liquid will collect and block ventilation, causing odor.
	Fan has failed	Have your serial number ready and call SUN-MAR for a replacement. Instructions are included with the replacement fan.	The fan is a constantly moving part and has a finite service life.
	Downdraft	If you believe that there may be a downdraft outside of the building, it may be a good idea to remove your fan assembly prior to installation and set the fan gate to '0' to prevent urine odor in the bathroom. (electric)	
	Competing appliances (CENTREX 3000 NE)	Wood stoves or furnaces installed in a tightly sealed room with the composting toilet may draw air in causing a vacuum in the room. This will draw air down the vent pipe.	Downdraft is dependent on wind direction as well as natural obstructions etc. Initially, install the vent above the peak of the roof.
Occasional Urine Odor Outside	1) Vent stack not installed above peak of roof. 2) If vent stack is installed above roof line, natural obstructions, such as tall trees, being located in a valley or close to a hill may be causing downdraft.	1) Check that the vent is installed above the peak of the roof. If not, extend the vent. Guide wires may be necessary. 2) Add lime to the evaporation chamber – as much as you think necessary. You will have to rake more often if you do this. 3) SUN-MAR has a filter box available which will filter the ammonia out of the vented air in a downdraft situation. Call SUN-MAR for details.	If symptoms occur, add lime or a filter box.
Strong Sewage Odor	Compost is anaerobic	Begin following: “Compost troubleshooting” suggestions.	Follow “Ongoing Maintenance” and use proper bulking material.
Fan Noisy	Fan damaged in shipping or bearings are beginning to wear.	1) If it is rattling, it may need to be cleaned or the bearings are worn and the fan needs to be replaced. 2) A hum is the normal sound the fan will make. If you are in a very quiet setting it will be more noticeable. If this is the case, consider purchasing a fan speed control so that the fan may be turned down.	Clean the fan with a small brush and/or compressed air nozzle once a year. This will prevent wear and lengthen the life of your fan.

Symptom	Cause	Remedial Action	Prevention
Fan Not Working	Debris in fan or mechanical failure.	Remove the fan assembly from the unit and vacuum any dust out of the fan blades. Check the power source. If this does not remedy the problem, have your serial number ready and call SUN-MAR	The fan is a continuously moving part which will eventually have to be changed. Do Not turn on and off daily.
Liquid Build up/ Lack of Evaporation	Increased usage.	The amount of liquid varies substantially between installations. The overflow drain needs to be installed.	Install the overflow drain.
	Climactic conditions	Evaporation rates vary substantially with climatic conditions. Expect faster evaporation rates during warm dry weather.	
	Mineral salts may have accumulated in the evaporation chamber over time, reducing evaporation rates.	To remove these, fill the evaporation chamber with very hot water and 1/3 bottle of "Compost Quick" enzyme liquid. Leave overnight.	Rake evaporating chamber at spring start ups for cottage use, and once every other month for residential use.
Liquid Overflow	Drains Blocked	<p>Drain all Liquid through the overflow drain by tipping the unit up (make sure overflow is hooked up first)</p> <ol style="list-style-type: none"> 1) Rake peat moss away from the safety drains. This is the "build up" area. If drains are still clogged, proceed to step 3. 2) Check drain line for kinks, blockages or Upward bends. Remove and flush if blockages present, un-kink if bent and ensure that the drain pipe is sloping downward. If your drain pipe is in order, proceed to step 3. 3) Use a wire to poke blockage out of the drain assembly. A brown spot will be visible through the opaque assembly. 	<ol style="list-style-type: none"> 1) A clogged drain is not very likely to happen if evaporating chamber is raked every 3-4 months. 2) Use premium 1"ID hose for the drain line. A good hose will be less likely to kink. Use elbows or fittings around bends to prevent kinks. 3) Use Compost Sure Blue as a bulking material.
	Overflow drain not hooked up	Connect overflow safety drain	Evaporation will slow during damp weather, make sure drain hose is installed.
	Unit tipped forward	Check and ensure that the unit is level.	

Symptom	Cause	Remedial Action	Prevention
Heating System Not Working	Test to determine whether failure has occurred	Pull finishing drawer out and put your hand in the evaporation chamber (NOT in the liquid). If there is no warmth rising from the floor of the unit, your heating system is not working. It is most commonly the thermostat that has failed. If you notice a lack of evaporation, but there is still warmth in the heating chamber, see "Liquid Build up" for solutions.	A ground fault interrupter circuit is recommended to protect your CENTREX 3000 Toilet from power surges that could cause your heating system to malfunction.
	Thermostat Failure	Have your serial number ready and call SUN-MAR for a replacement. (Detailed instructions are included with the replacement part)	Your thermostat and fan are the two constantly moving parts on the unit, and so are the most likely to fail.
	Heating Element Failure	If the insulation behind the electric box is moist or discolored, or heating does not work after the new thermostat has been connected, then the heating element has failed.	Both are easy to replace. If you ever remove the unit for cleaning, DO NOT use a water hose around the base of the unit.
	Blown fuse (some 230V units ONLY)	Have your serial number ready and call SUN-MAR for a replacement. (Detailed instructions are included with the replacement part) Check fuse located on the electric box to ensure that it is functioning correctly, if the wire in the fuse is charred or broken, replace the fuse.	Power surges can cause the fuse to blow. If this is a possibility in your area, a surge protector is recommended.
Liquid in Finishing Drawer	Drum Screen Clogged	Remove the finishing drawer. The drum screen is located on the bottom of the patented Bio-drum, to the left of the drawer opening. Scrub drum screen with a wire brush.	Scrub drum screen with a wire brush.
Drum Will Not Turn	Set screw securing handle to shaft has broken	Drill out set screw and replace, or have your serial number ready and call SUN-MAR for a handle replacement kit (instructions included).	Drum should never be more than ½ full.
	Steel roll-pin securing gear wheel to shaft has broken	Have your serial number ready and call SUN-MAR for a replacement small gear kit.	
Drum Door Not Opening/ Closing Properly	Drum too full Hinges Stuck	Spray hinges with Compost Quick. Scrub hinges with toothbrush or other soft nylon bristled brush.	

Basic Maintenance Instructions

Ultra low flush toilet and CENTREX 3000 Units

These instructions are not to replace the owner's manual, but are intended as simple instructions for daily use.

USING THE TOILET

Deposit your toilet paper, step on the foot pedal to flush, close the lid and walk away...your job is done. If you plan on making a more substantial deposit and would like more water in the bowl, simply lift the foot pedal up and the bowl will fill. When you have the desired amount of water, let the pedal drop back in place and do what you have to do.

EVERY OTHER DAY

Turn the handle to mix and aerate the compost. If the toilet is being used predominantly for urination, be sure to add at least one cup of bulking mixture (added at the composting unit) per average amount of users per day. At the composting unit (not the flush toilet), open the access port to the drum. Add Compost Sure at the rate of one cup per person per day, so, if there are two people staying, you would add 4 cups of Compost Sure all at once (2 people x 2 days = 4cups). To avoid messy waste pipe obstructions, Compost Sure should always be added at the composting unit, not the flush toilet. Grasp the crank handle and turn in a clock-wise direction for 10 complete turns of the drum . Keep in mind that one revolution of the drum = 7 complete turns of the handle. When the drum has been turned the required amount of turns, turn the handle counter clockwise until you feel resistance on the handle. **THIS IS REALLY IMPORTANT!** By turning the handle counter clockwise, you are centering the opening in the drum under the waste pipe. To ensure that there are no messy accidents, do not skip this step!!







CHECK THE VOLUME OF THE BIO-DRUM™

To speed up composting, add one scoop of Microbe Mix every second week, and ensure that the drum is not more than ½ full.

ATTENTION: the Centrex 3000 electric model must remain plugged in to an electrical outlet continuously to function in an odorless fashion. If you will be away from the residence where the composting toilet is installed for longer than three days, the power may be disconnected while the composting toilet lays dormant.

ACCESSORY ITEMS FOR THE CENTREX 3000 TOILET

SUN-MAR has developed a number of composting accessory items over the years in response to frequent requests from users. These items may serve to improve composting speeds under some circumstances.

Name	Description	Container
“Compost Quick”	Cleans and accelerates the composting action of your Sun-Mar composting toilet. Compost Quick is a specially selected natural enzyme solution that also assists in the decomposition of waste. 100% natural and non-toxic. 500ml(16oz) Bottle	
“Microbe Mix”	100% natural product combining a blend of microbes and enzymes designed to start and accelerate composting in all Sun-Mar toilets. 500g (16oz) Jar	
“Compost Sure Blue”	For use with all Sun-Mar low water CENTREX systems. Compost Sure Blue’s mix enriches compost with organic carbon and also provides drainage of excess liquid ensuring compost remains aerobic and odor-free. 30 Litre/8 Gallon Bag	
DC Vent Kit	Kit required for conversion of electric units to also operate without electricity or 12 volt DC mode. Includes a 12 volt DC fan.	
AF Waterless Kit	Purchase of a SUN-MAR dry toilet necessary. This kit will adapt a CENTREX 3000 for use without water. Ideal where water supply is limited or low output is desired.	
AC Fan Speed Control	Designed for electric units only, the control kit allows users to adjust the speed of the fan. Ideal for installations where the toilet is used in winter applications or in bunkies where the toilet may be in close proximity to sleeping quarters.	
12 Volt 2.4 Watt Fan	Designed for use in the 4” non-electric vent only. This fan increases the air flow in non-electric units to help overcome down draft.	

Note: Use “Compost Sure Blue” for optimum results.

CENTREX 3000 SPECIFICATIONS

CENTREX 3000 EXPLOSION DIAGRAM & PART NUMBERS

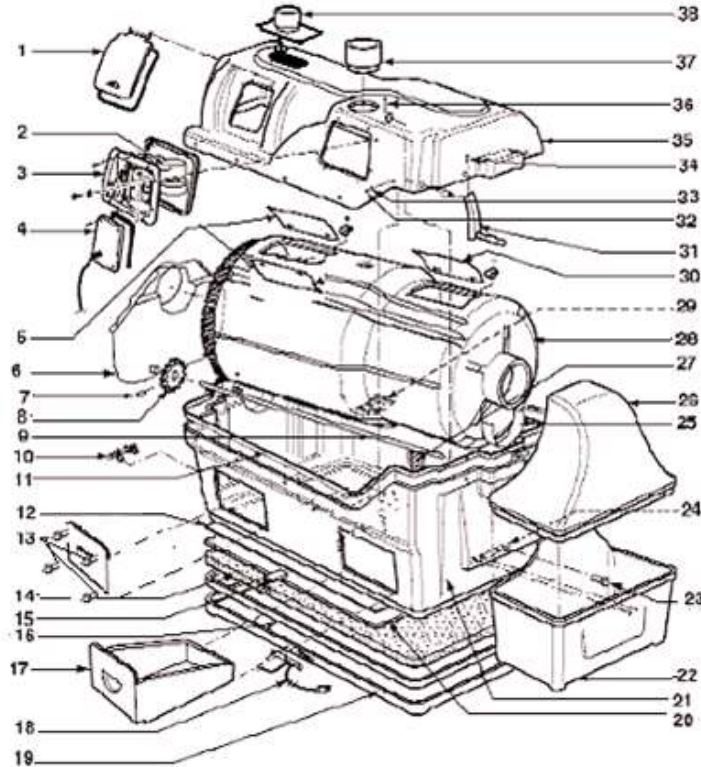

- 1 Centrex 3000 Access Door
- 2 Fan (Electric)
- 3 Fan Assembly Housin (Electric)
- 4 Plastic Fan Motor Cover (Electric)
- 5 Centrex 3000 Drum Doors
- 6 Centrex 3000 Bearing Plate
- 7 Roll Pin
- 8 Nylon Drive Gear
- 9 Centrex 3000 Shaft Assembly
- 10 1" (25mm) Drain Assembly
- 11 Rubber U Channel
- 12 Aluminum Sheet (Electric)
- 13 Centrex 3000 Access Panel and Thumbscrews

- 14 Insulation (Electric)
- 15 Thermostat (Electric)
- 16 Rubber U Channel
- 17 Centrex 3000 Drawer
- 18 Power Cord
- 19 Centrex 3000 Heating Tray
- 20 Heating Element
- 21 Centrex 3000 Tank
- 22 Collection Bin Bottom
- 23 Drum Locker Thumb Screw
- 24 Drum Locker
- 25 Drum Bearing Strip
- 26 Collection Bin Top

- 27 3" (75mm) Air Intake
- 28 Centrex 3000 Drum
- 29 Drum Screen
- 30 Centrex 3000 Drum Door
- 31 Handle
- 32 Washer Plastic CSK
- 33 Screw #8 X 5/8" SS
- 34 Set Screw
- 35 Top Centrex 3000
- 36 Roll Pin
- 37 4" (100ml) Vent Inlet (NE)
- 38 Cover Plate

Wiring Diagram

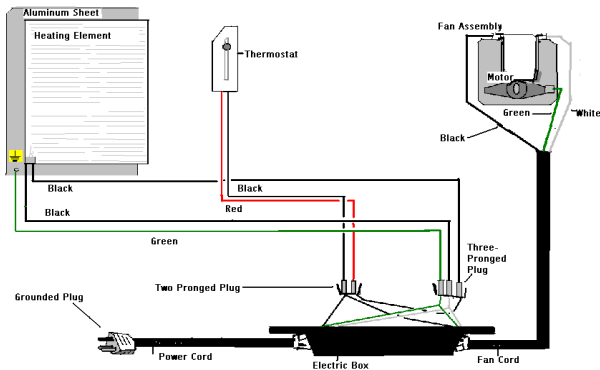

Electrical Specifications	115V	240V
Maximum Amps	3.6	1.69
Fan Watts (Required)	35 req.	35 req.
Heater Watts (When on)	370	370
Average Power Use In Watts (Heater on 1/2 time)	200	200

WARRANTY

SUN-MAR Corp. warrants the original purchaser that this toilet is free from defects in material and workmanship under normal house or cottage use. SUN-MAR Corp. will furnish new parts for any part that fails within three years and five years on the fiberglass tank, provided that our inspection shows that such failure is due to defective material or workmanship. Any part supplied by us to replace another part is warranted for the balance of the original warranty period.

This warranty does not cover:

1. Damage resulting from neglect, abuse, accident or alteration; or damage caused by fire, flood, acts of God or any other casualty.
2. Parts and accessories not sold or manufactured by SUN-MAR Corp. or any damage resulting from the use of such items.
3. Damage or failure resulting from failure of the purchaser to follow normal operating procedure outlined in the Owner's Manual or in any other printed instructions.
4. Labor and service charges incurred in the removal and replacement of any parts found defective under the terms of this warranty.
5. All returns to the factory must be made freight prepaid. All shipments from the factory are made F.O.B. the factory.

This warranty is in lieu of all other warranties expressed or implied, and no person is authorized to enlarge our warranty responsibility, which is limited to the terms of this certificate. The Company reserves the right to change, improve or modify its products without obligation to install these improvements on equipment previously manufactured.

Sun-Mar

Product Info: (905) 332-1314 Fax: (905) 332-1315 Tech. Service: (888) 341-0782 Ext 218
E-mail: compost@sun-mar.com <http://www.sun-mar.com>

600 Main St.
Tonawanda, N.Y.
14150-0888 U.S.A.

5370 South Service Rd.
Burlington, ON
L7L 5L1 CANADA